

Splice machine

- **CRIMP FORCE MONITOR**
- **COMPONENT POSITION MONITORING**



Splice connections

WHY SM CRIMP 2000?

FULL PROCESS CONTROL (FPC) SOLUTION

- Splice connection professional qualification
- In-line quality control (*ref. quality control equipment documentation: EPT 1000, SK 4000 & SK 6000; and measurement software Viso 6.00 documentation*)

MACHINE STABILITY

- Tooling designed for symmetrical connection
 - Tooling cassette change within 1 minute
- Clincher with a pre-defined position - doesn't require height adjustment
- Built-in camera for the component position monitoring
 - Crimp force control monitor STARLITE
- Possibility of full automation with our SCS solutions
- Finger guard lighting cap for easy and safe operation
- Stand-alone unit or machine integrated in a product line

Splice application

Crimp width depends on the width of the crimping ribbon chosen. There are three standard widths according to its application:

- 2 mm: electronics and low-current applications, general applications;
- 4 mm: general applications;
- 6-7 mm: power connections, high tensile strength.

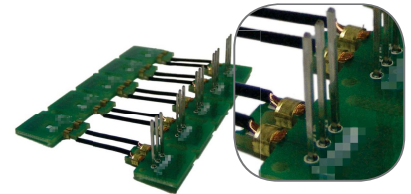

Automotive industry

Crimp connections are commonly used in the automotive industry. One of the reasons is absence of soldering step. Soldering & welding can damage the components and the conductor because of heating. Crimp connection doesn't involve heating and thus is more resistant to bending and vibrations.

Following industry manufacturers sectors are also large-scale consumers of splices: domestic appliances, light processing, medical engineering, and data processing.



Wire and splice

This application demonstrates the flexibility of uses of the splice's universal endless strip. It is possible to perform various connections using the same splice ribbon (defining and using adapted tooling). The tool cassette can be prepared to cover a wide range of cross-sections e.g. 0.5-1.5 mm².

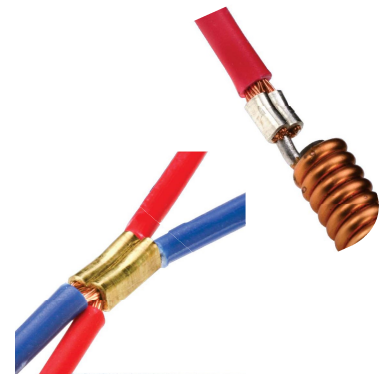

Printed circuit boards

PCBs are used increasingly where space is at a premium. This applies particularly in automotive engineering, indoors applications or roof cladding. Standard connectors are unacceptable as concerns to saving space. Splice allows to make flat connection with minimum dimensions – ideal for sensors, bulbs, heating elements, etc.

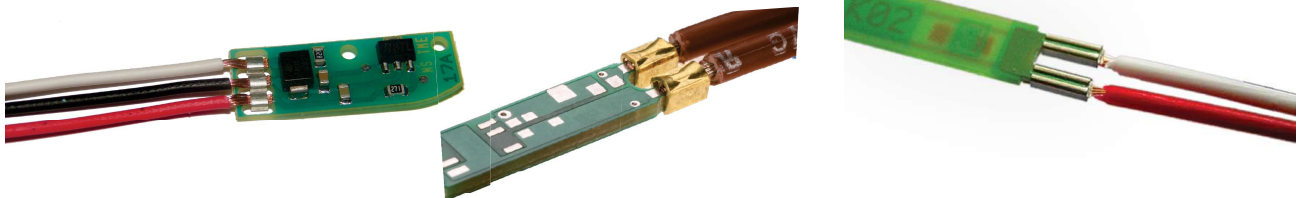

Splice connections

www.smcontact.eu

Defining the splice

Connection simulation

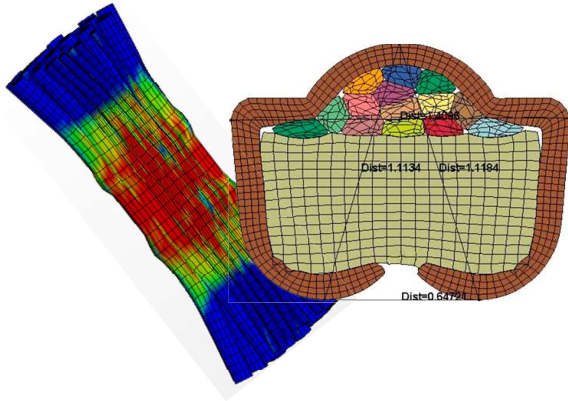

Samples production



Thermal shock test

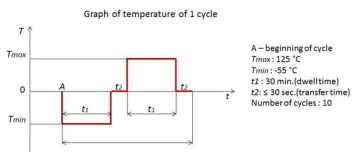

Total: 26 samples (10+10+5+1)

- 10 Pull force test
- 10 Ω check *Thermal cycling* Ω check → Pull force test
- 5 Ω check *Thermal cycling* Ω check → Cross section analysis
- 1 Ω Ref. → Ω Ref.

Pull force measurement

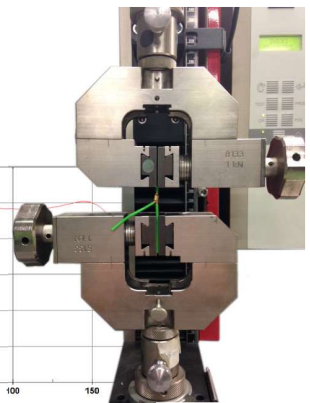
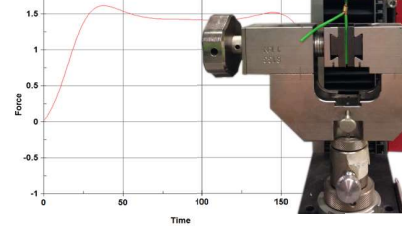

Electric resistance test

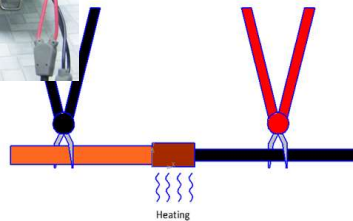

Technical report



SM Crimp 2000

SM Crimp 2000 forms solderless crimp connection of two components by crimping a metal clip onto the ends of the components. **Crimp force monitor Starlite** and **built-in camera for the component position monitoring** make this equipment favorable for production with high quality of every single product.

Technical data

Power supply:	230 V / 50 Hz for single-phase
---------------	--------------------------------

Absorbed power:	500 W
-----------------	-------

Motor rating:	300 W
---------------	-------

Cycle time:	300 ms
-------------	--------

Front depth of throat:	75 mm
------------------------	-------

Noise level:	< 75 dBA
--------------	----------

CE conformity	
---------------	--

Dimensions (incl.handwheel)

Width:	291 mm
--------	--------

Height:	340 mm
---------	--------

Depth:	490 mm
--------	--------

Weight:	ca. 56 kg
---------	-----------



Crimp Force Monitor
& Component Position
Camera Control



Finger guard
lighting cap

Crimp Force Monitor Starlite

- Various triggering methods such as proximity, encoder and automatic triggering by the force itself
- A wide range of force sensors and adaption plates (either on the ram or base plate)
- Automatic rejection of defective items
- Suitable to any application

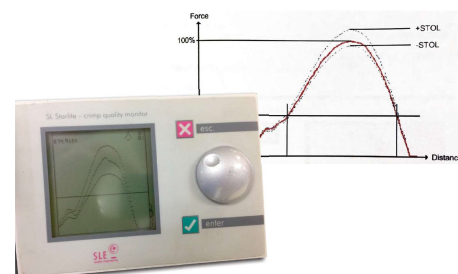

Splice connections

Cutting unit Poka Yoke

If the Crimp Force Monitor detects a defective product, the cutting unit Poka Yoke automatically cuts off the connection. The blade is driven by a pneumatic cylinder.

Cast iron frame

In contrast to the machines assembled from separate parts by screws, SM Crimp 2000 cast iron frame warrants a perfect stability during crimping.

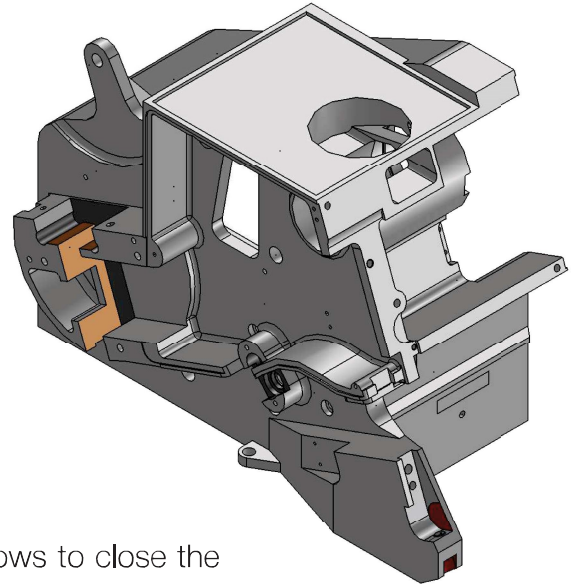

Inclined clincher surface

The inclined surface of the deepening of the clincher allows to close the connection more tightly and avoid spring-back of the material.

Its pre-defined position doesn't require height adjustment.

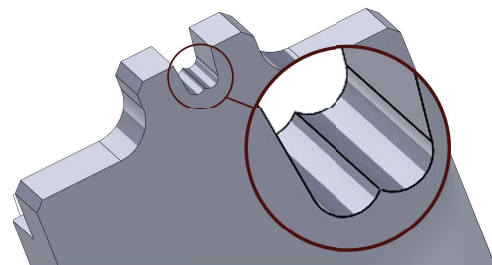
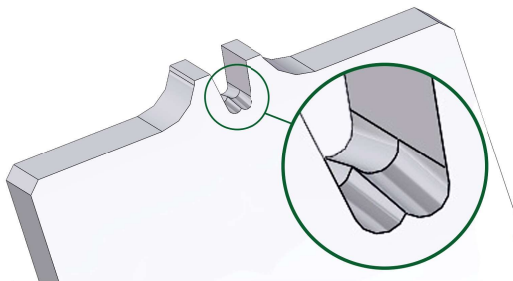

Splice ribbon length control

Precise feed of band material for each splice is provided automatically with ribbon length control by the sensor.



Smooth cutting surface

The work surface of the punch guide and cutting block is smooth, unlike the other tooling with teeth surface featured on the market.

Smooth cutting surface provides symmetrical connection and very good cross-section views.

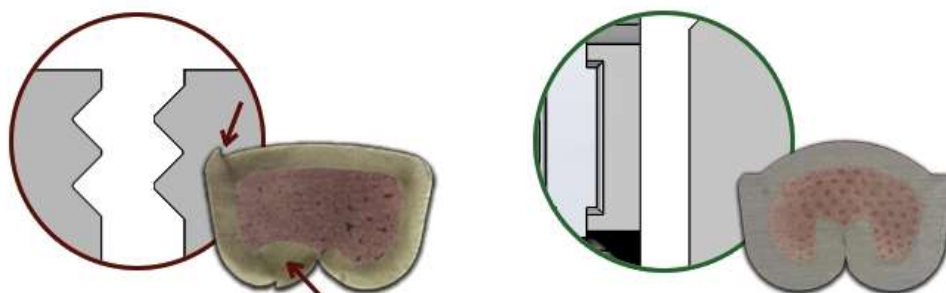

Motorized feeding system

Band feeding system controls the length of each splice precisely (permanent for every circle) and prevents damages of the splice ribbon surface due to rubber feeding wheel.

Slow compression principle

“Slow compression” principle implies that the system slows down the forming speed and extends the compression phase of the upper punch on the connection. Therefore the metal has time to achieve the desired form. The closure of the crimp connection is improved and has no “burrs” because there are virtually no impact and shear forces acting on the connection.

“Slow compression” is used for processing connections from 6 to 10 mm².

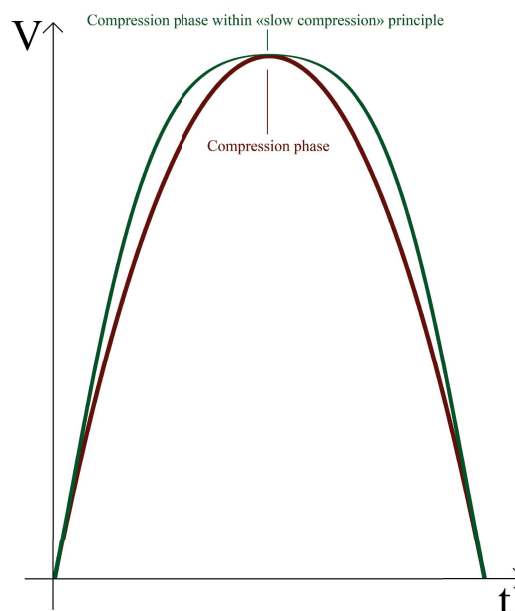

Splice connections

www.smcontact.eu

SM Crimp on YouTube



SEE MORE
SMCONTACT.EU



SM CONTACT CORPORATION

77860 Quincy Voisins
France
20 à 22, Voie Gallo Romaine
Tel.: +33 (0)1 64 63 66 66
Fax: +33 (0)1 64 63 67 22
smcontact@smcontact.fr

SM CONTACT GMBH

D-66113 Saarbrücken
Germany
Lebacher Str., 4
Tel.: +49 (0) 9127 9536714
sales_de@smcontact.eu

SM CONTACT ENGINEERING

196191 Saint-Petersburg
Russia
21-A, Basseynaya Str.
Tel.: +7 812 980 97 93
info@smcontact.ru

SM CONTACT ASIA

555 Panyu RD • GuangZhou
China
205 Exchange Center TianAn
Hi-tech Ecological park
Tel.: +86 (0)20 22883182
info@smcontact.cn